

HAMBURG

DIMENSION

DIMENSIONS

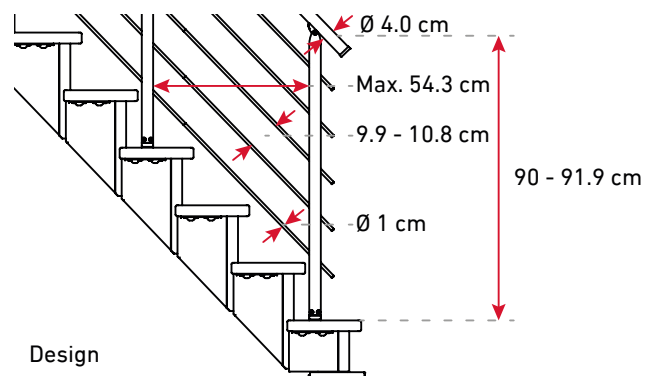
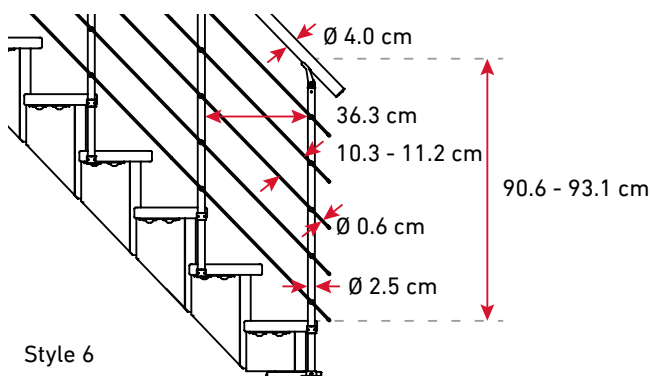
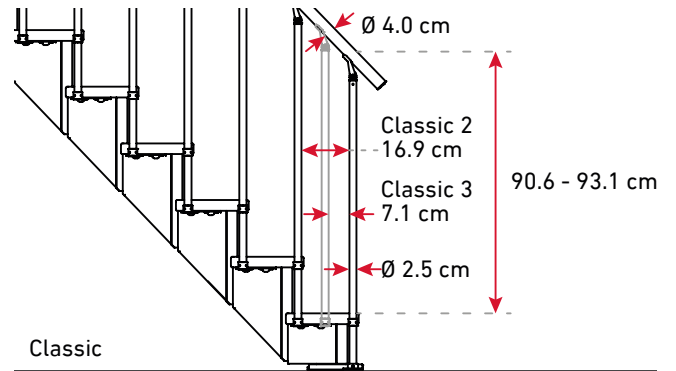
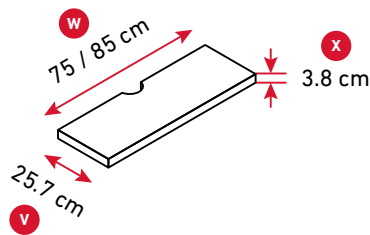
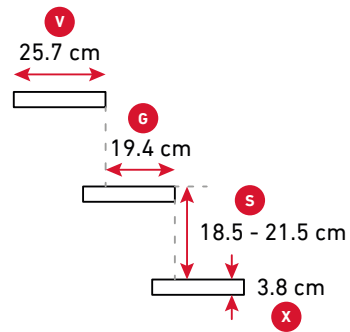
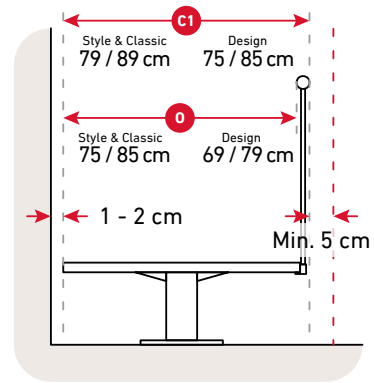
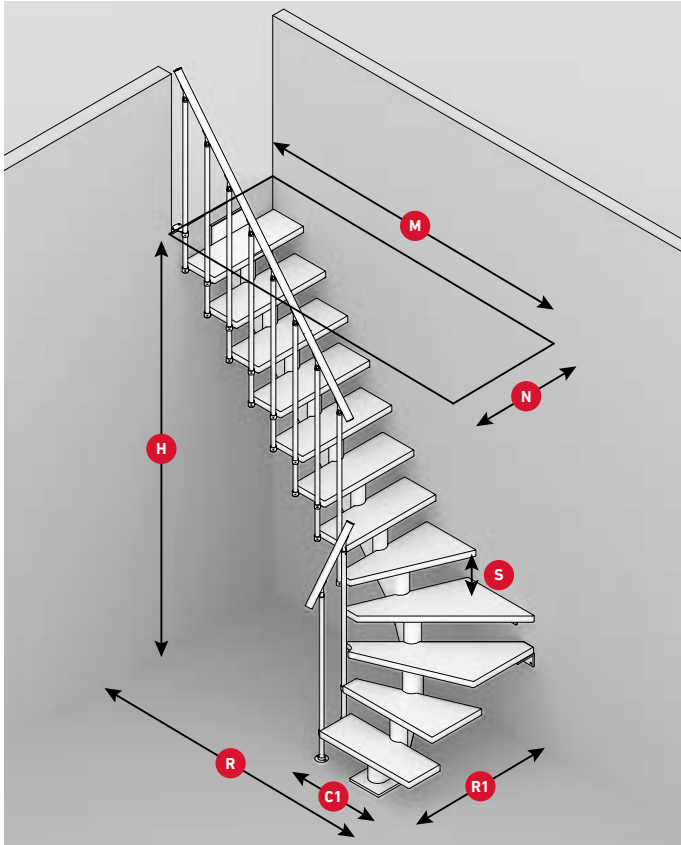

DIMENSIONS

- H** (14T) 277.5 - 322.5 cm
- (13T) 259 - 301 cm
- (12T) 240.5 - 279.5 cm
- (11T) 222 - 258 cm
- (10T) 203.5 - 236.5 cm
- (9T) 185 - 215 cm

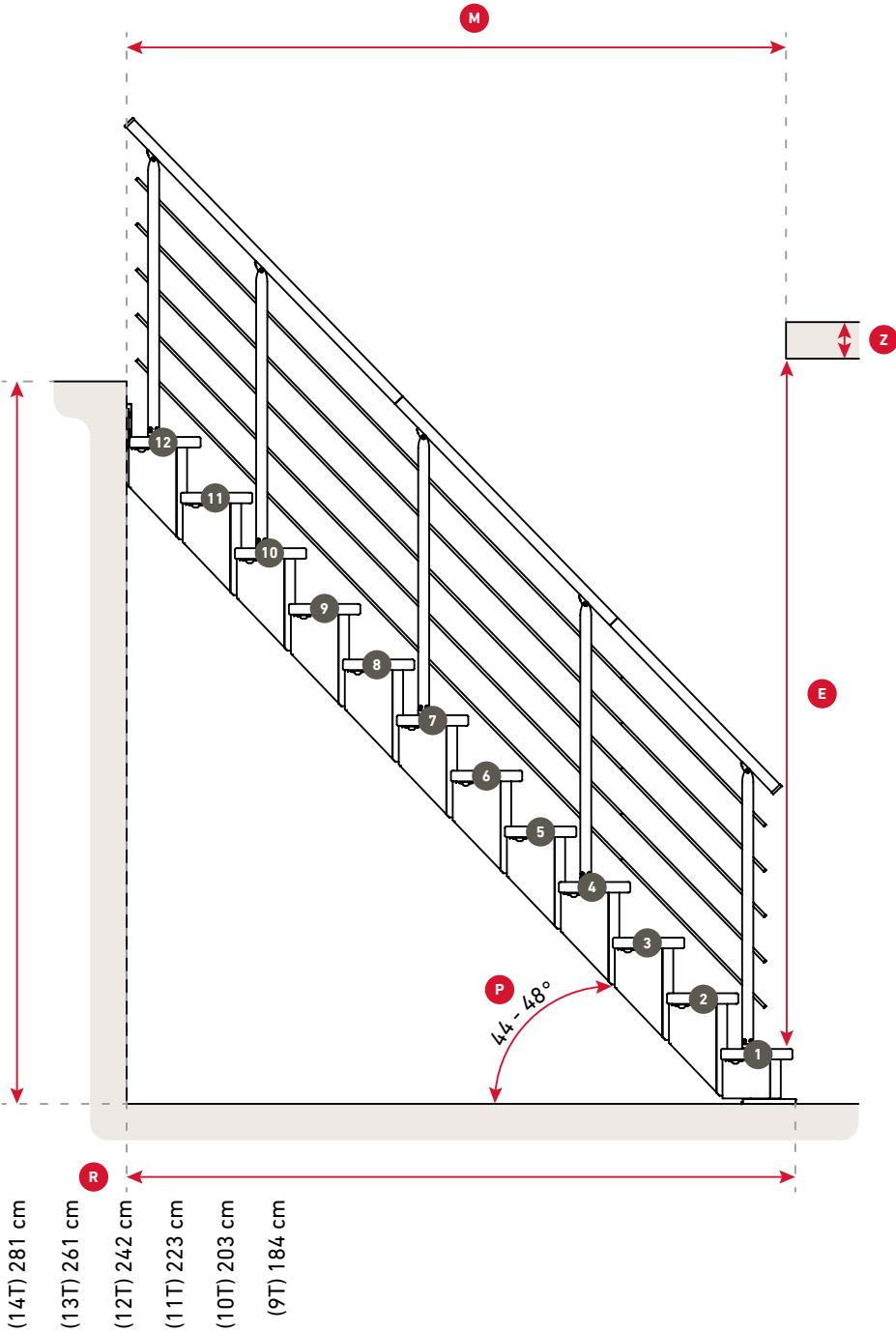

HAMBURG 11 TREADS - WIDTH 75 CM

H 222 - 258 cm

— Staircase dimensions incl. Classic/Style 6 banister on 1 side. See p. 5 for staircase width (C1) with Design banister.

- - Floor opening size is defined based on 2 cm space to wall, 5 cm space for hand, 19 cm rise height, 25 cm deck thickness, 200 cm headspace.

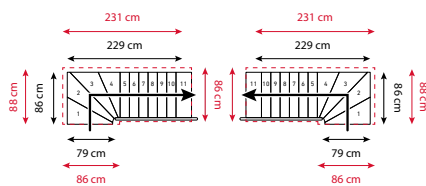
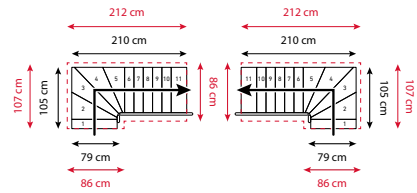
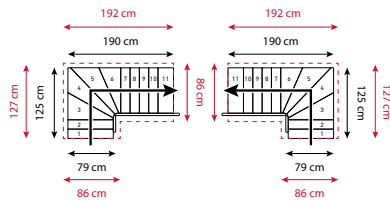
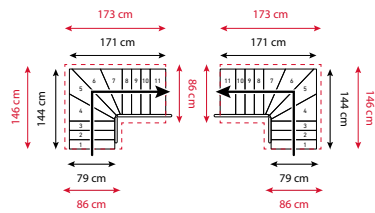
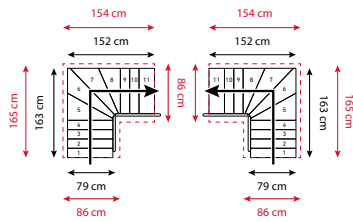
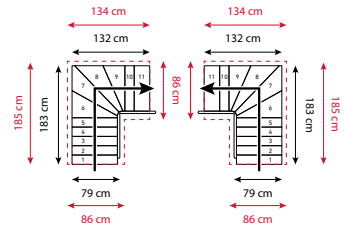
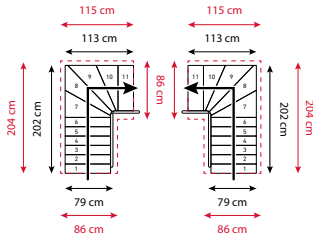

HAMBURG 12 TREADS - WIDTH 75 CM

H 240.5 - 279.5 cm

— Staircase dimensions incl. Classic/Style 6 banister on 1 side. See p. 5 for staircase width (C1) with Design banister.

- - - Floor opening size is defined based on 2 cm space to wall, 5 cm space for hand, 19 cm rise height, 25 cm deck thickness, 200 cm headspace.

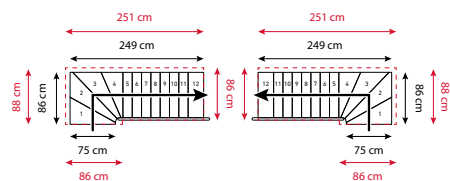
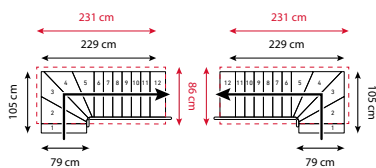
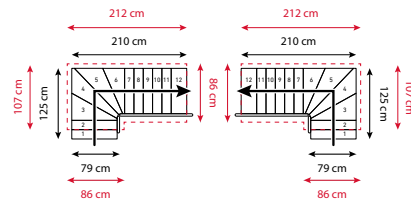
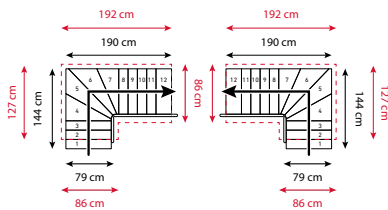
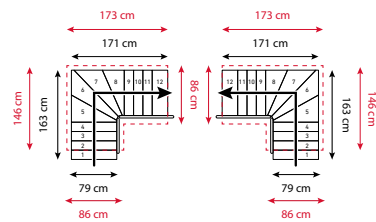
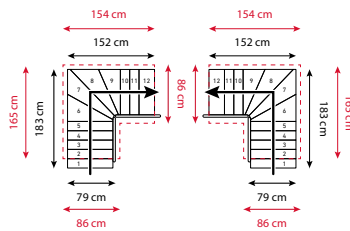
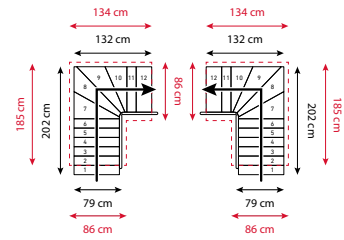
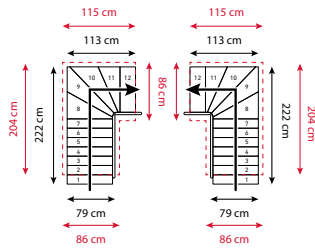

HAMBURG 13 TREADS - WIDTH 75 CM

H 259 - 301 cm

— Staircase dimensions incl. Classic/Style 6 banister on 1 side. See p. 5 for staircase width (C1) with Design banister.

- - - Floor opening size is defined based on 2 cm space to wall, 5 cm space for hand, 19 cm rise height, 25 cm deck thickness, 200 cm headspace.

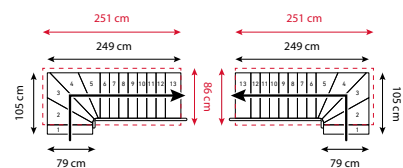
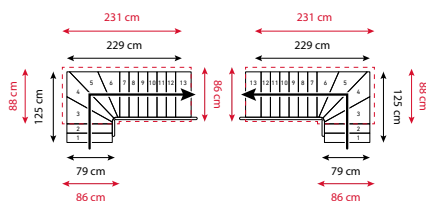
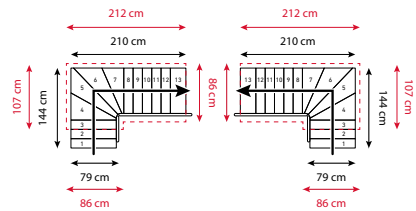
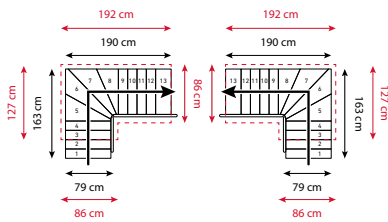
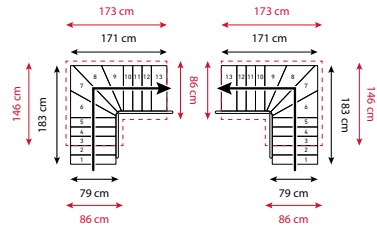
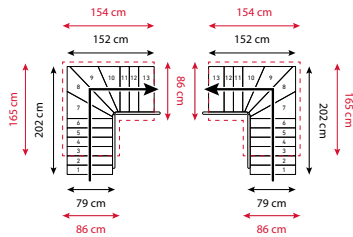
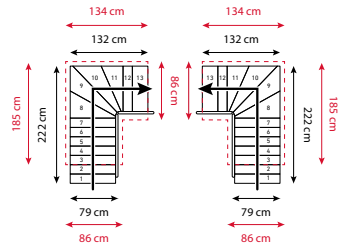
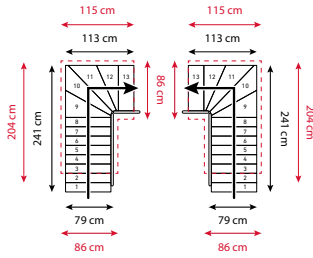

HAMBURG 13 TREADS - WIDTH 75 CM

H 259 - 301 cm

— Staircase dimensions incl. Classic/Style 6 banister on 1 side. See p. 5 for staircase width (C1) with Design banister.

- - - Floor opening size is defined based on 2 cm space to wall, 5 cm space for hand, 19 cm rise height, 25 cm deck thickness, 200 cm headspace.

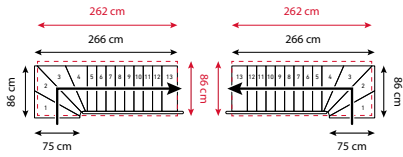

HAMBURG 14 TREADS - WIDTH 75 CM

H 277.5 - 322.5 cm

— Staircase dimensions incl. Classic/Style 6 banister on 1 side. See p. 5 for staircase width (C1) with Design banister.

- - Floor opening size is defined based on 2 cm space to wall, 5 cm space for hand, 19 cm rise height, 25 cm deck thickness, 200 cm headspace.

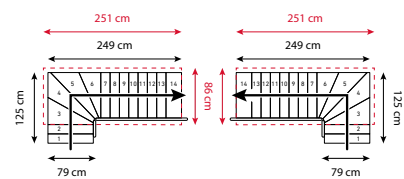
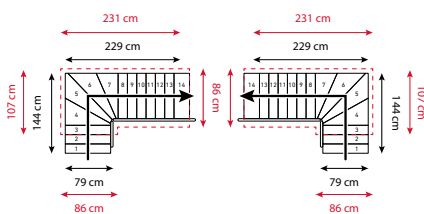
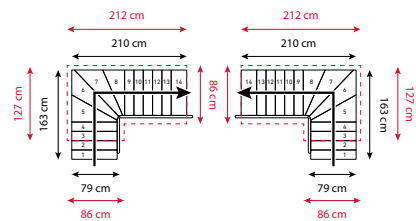
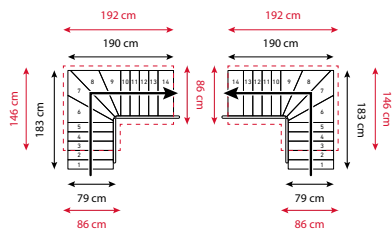
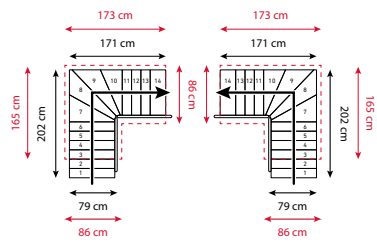
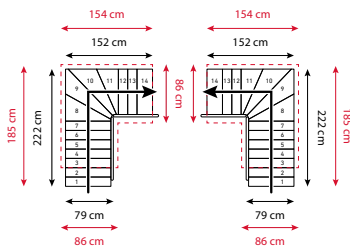
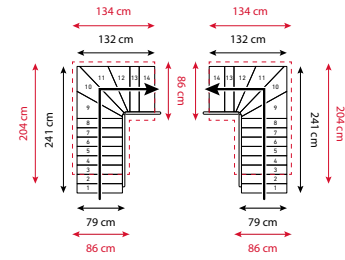
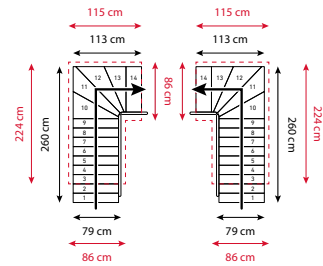

HAMBURG 14 TREADS - WIDTH 75 CM

H 277.5 - 322.5 cm

— Staircase dimensions incl. Classic/Style 6 banister on 1 side. See p. 5 for staircase width (C1) with Design banister.

- - - Floor opening size is defined based on 2 cm space to wall, 5 cm space for hand, 19 cm rise height, 25 cm deck thickness, 200 cm headspace.

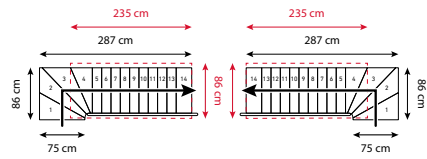
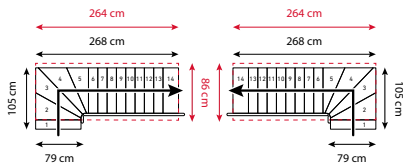

HAMBURG QUARTER TURN DIMENSIONS

