

# HAMBURG

## DIMENSION

# DIMENSIONS

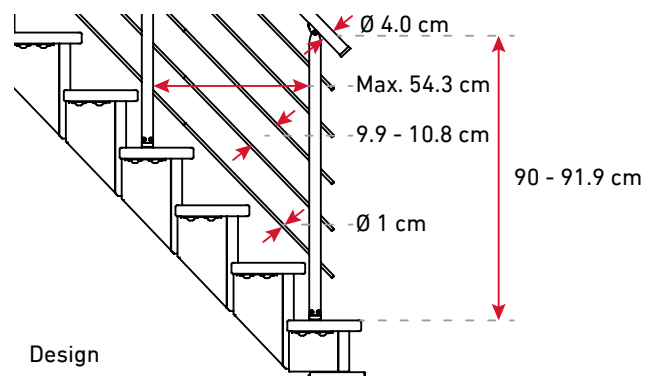
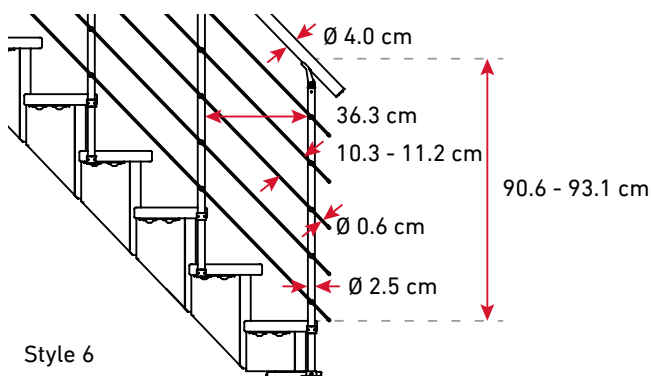
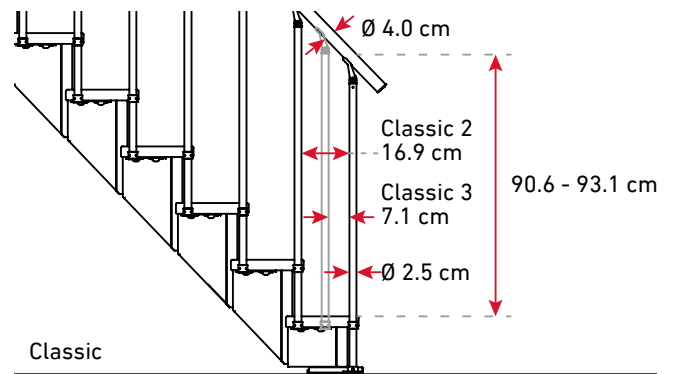
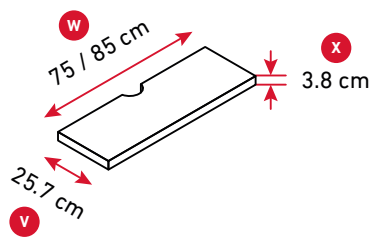
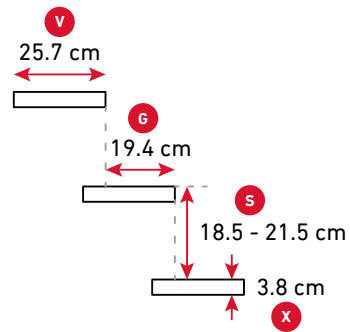
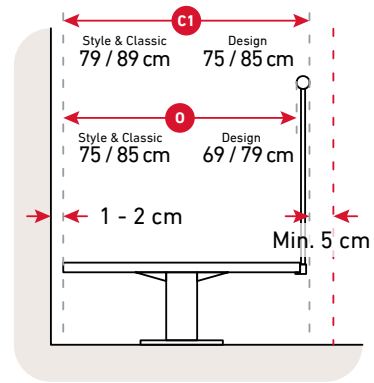
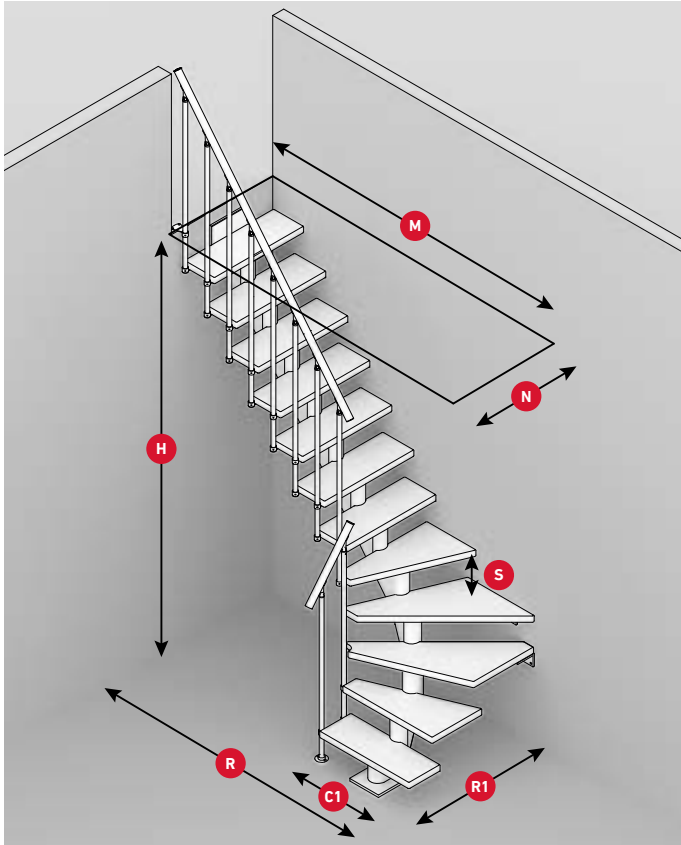

# DIMENSIONS

- H** (14T) 277.5 - 322.5 cm
- (13T) 259 - 301 cm
- (12T) 240.5 - 279.5 cm
- (11T) 222 - 258 cm
- (10T) 203.5 - 236.5 cm
- (9T) 185 - 215 cm

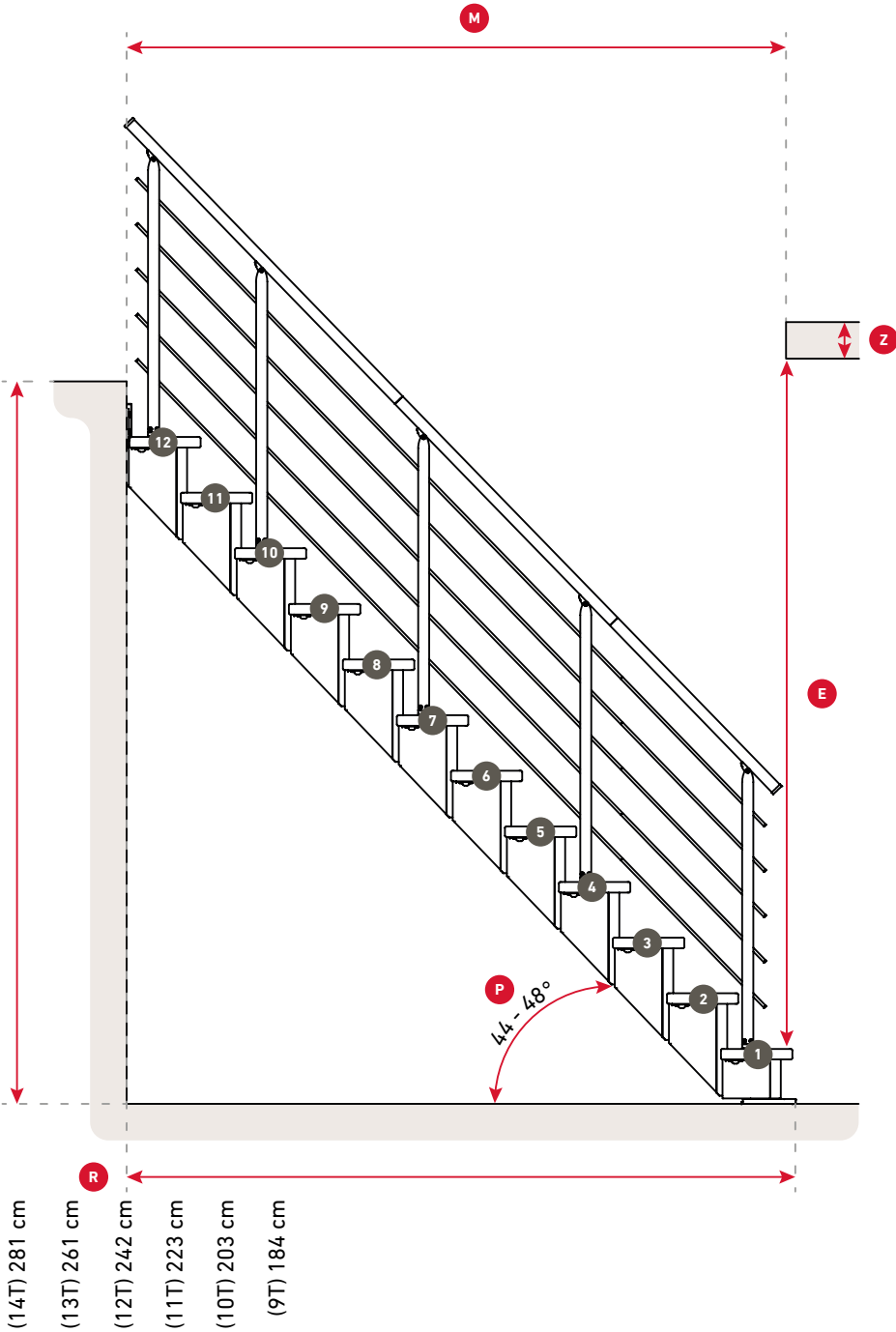

# HAMBURG 11 TREADS - WIDTH 85 CM

**H** 222 - 258 cm

— Staircase dimensions incl. Classic/Style 6 banister on 1 side. See p. 5 for staircase width (C1) with Design banister.

- - - Floor opening size is defined based on 2 cm space to wall, 5 cm space for hand, 19 cm rise height, 25 cm deck thickness, 200 cm headspace.

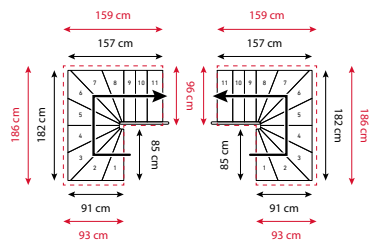
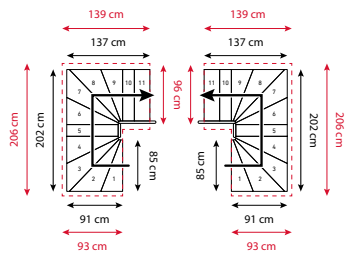
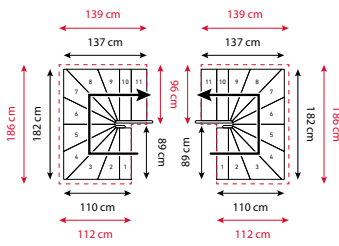
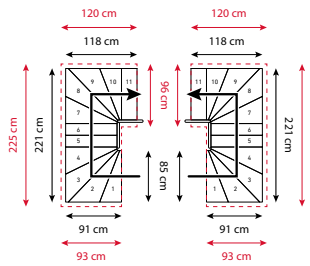
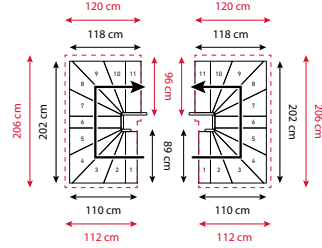
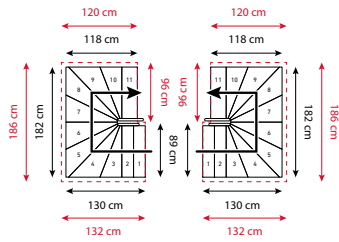

# HAMBURG 12 TREADS - WIDTH 85 CM

**H** 240.5 - 279.5 cm

— Staircase dimensions incl. Classic/Style 6 banister on 1 side. See p. 5 for staircase width (C1) with Design banister.

- - Floor opening size is defined based on 2 cm space to wall, 5 cm space for hand, 19 cm rise height, 25 cm deck thickness, 200 cm headspace.

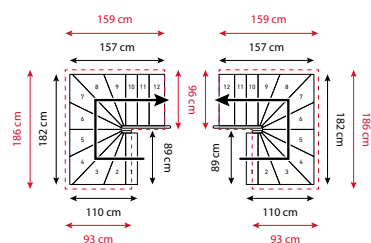
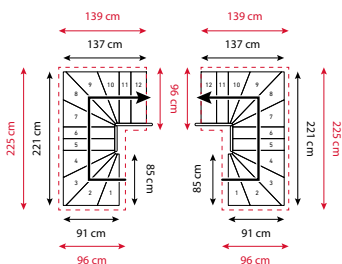
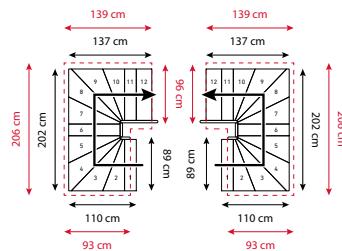
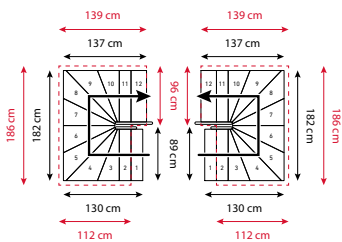
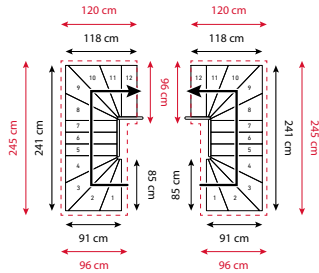
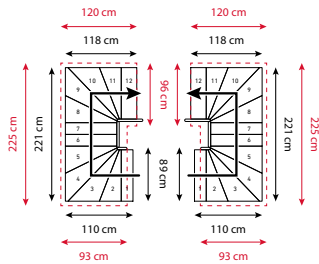
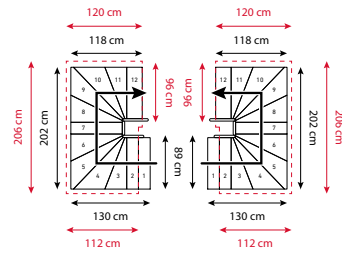
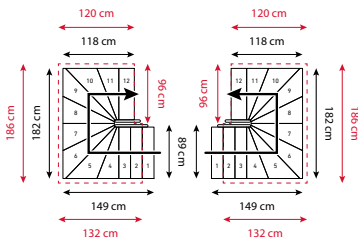

# HAMBURG 12 TREADS - WIDTH 85 CM

**H** 240.5 - 279.5 cm

— Staircase dimensions incl. Classic/Style 6 banister on 1 side. See p. 5 for staircase width (C1) with Design banister.

- - - Floor opening size is defined based on 2 cm space to wall, 5 cm space for hand, 19 cm rise height, 25 cm deck thickness, 200 cm headspace.

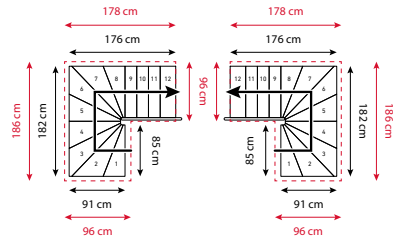
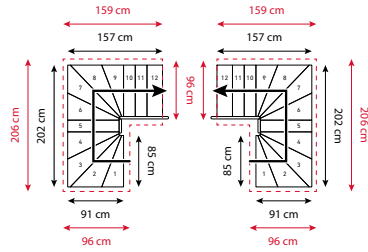

# HAMBURG 13 TREADS - WIDTH 85 CM

**H** 259 - 301 cm

— Staircase dimensions incl. Classic/Style 6 banister on 1 side. See p. 5 for staircase width (C1) with Design banister.

- - Floor opening size is defined based on 2 cm space to wall, 5 cm space for hand, 19 cm rise height, 25 cm deck thickness, 200 cm headspace.

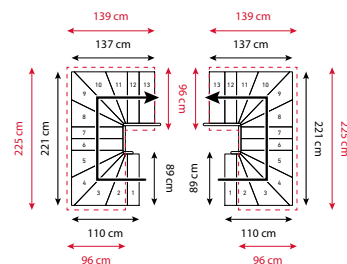
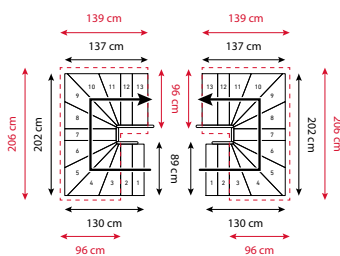
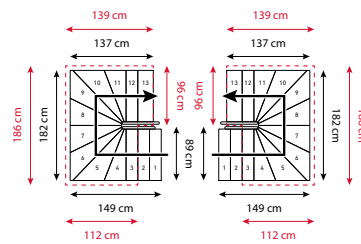
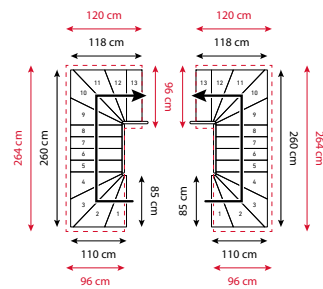
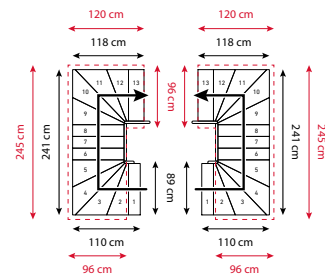
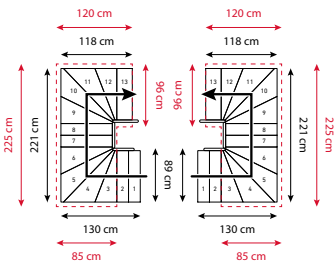
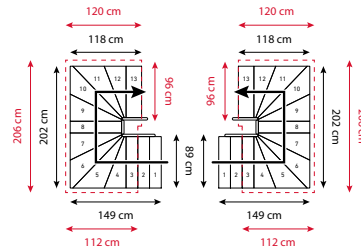
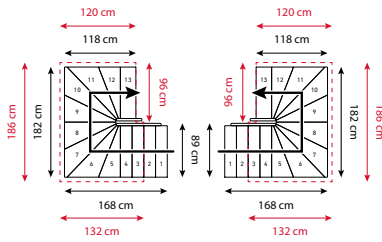

# HAMBURG 13 TREADS - WIDTH 85 CM

**H** 259 - 301 cm

— Staircase dimensions incl. Classic/Style 6 banister on 1 side. See p. 5 for staircase width (C1) with Design banister.

- - - Floor opening size is defined based on 2 cm space to wall, 5 cm space for hand, 19 cm rise height, 25 cm deck thickness, 200 cm headspace.

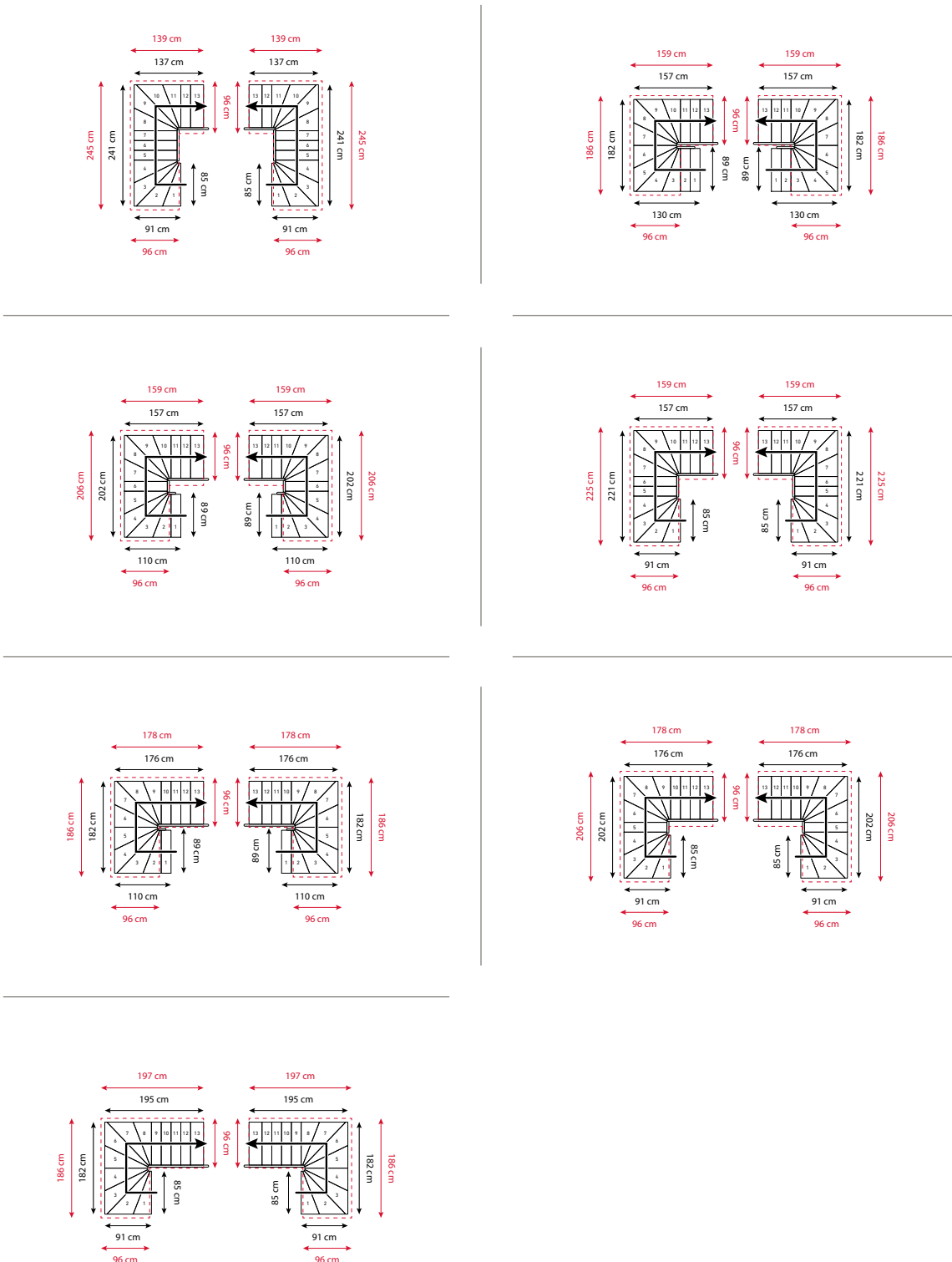



# HAMBURG 14 TREADS - WIDTH 85 CM

**H** 277.5 - 322.5 cm

— Staircase dimensions incl. Classic/Style 4 banister on 1 side. See p. 5 for staircase width (C1) with Design banister.

- - Floor opening size is defined based on 2 cm space to wall, 5 cm space for hand, 19 cm rise height, 25 cm deck thickness, 200 cm headspace.

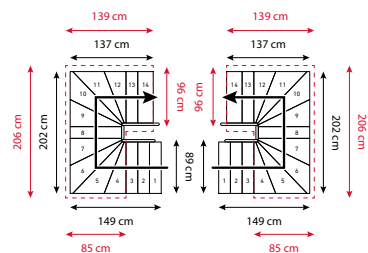
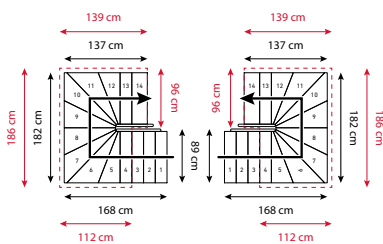
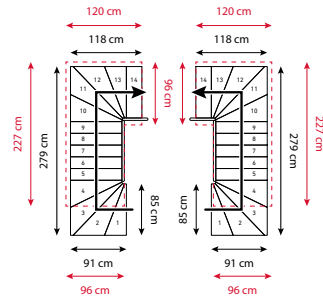
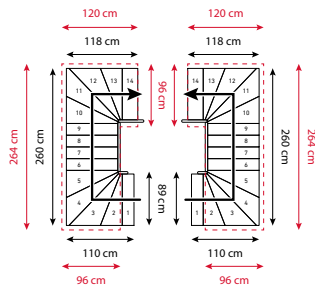
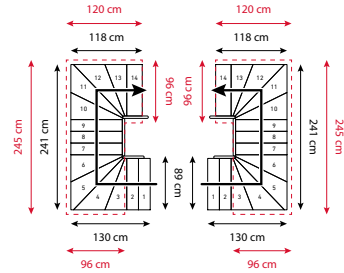
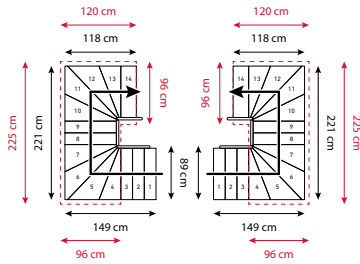
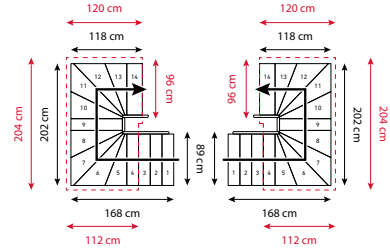
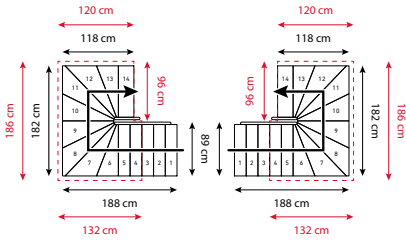

# HAMBURG 14 TREADS - WIDTH 85 CM

**H** 277.5 - 322.5 cm

— Staircase dimensions incl. Classic/Style 6 banister on 1 side. See p. 5 for staircase width (C1) with Design banister.

--- Floor opening size is defined based on 2 cm space to wall, 5 cm space for hand, 19 cm rise height, 25 cm deck thickness, 200 cm headspace.

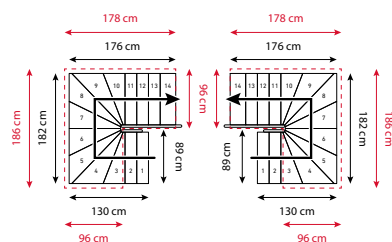
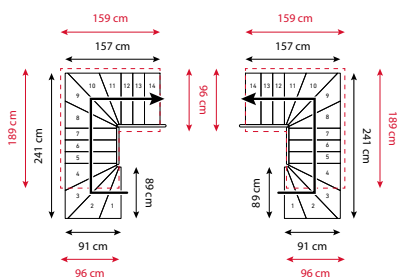
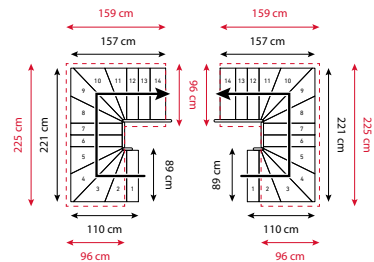
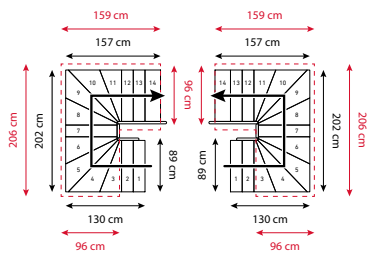
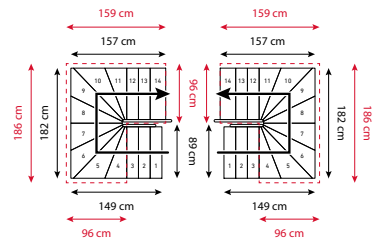
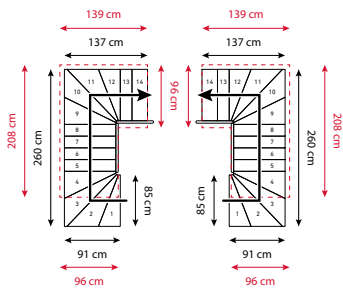
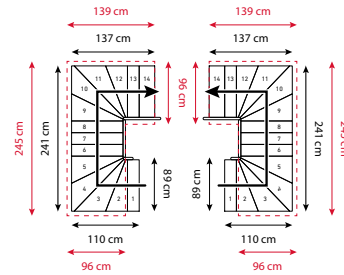
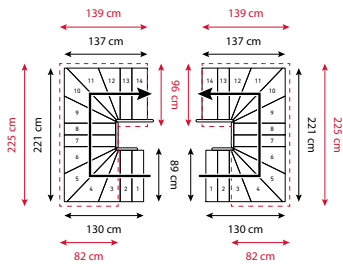

# HAMBURG 14 TREADS - WIDTH 85 CM

**H** 277.5 - 322.5 cm

— Staircase dimensions incl. Classic/Style 6 banister on 1 side. See p. 5 for staircase width (C1) with Design banister.

- - Floor opening size is defined based on 2 cm space to wall, 5 cm space for hand, 19 cm rise height, 25 cm deck thickness, 200 cm headspace.

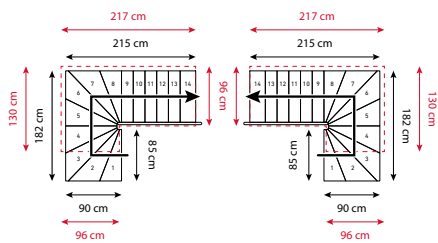
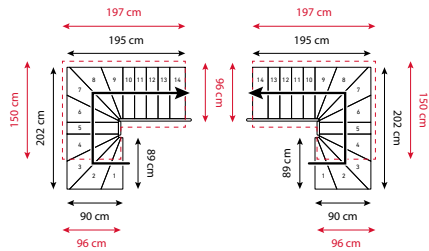
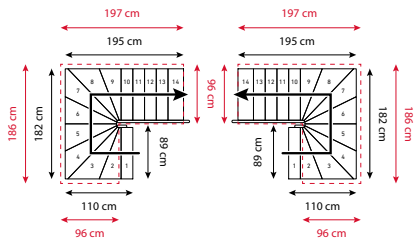
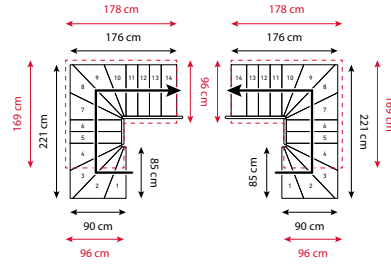
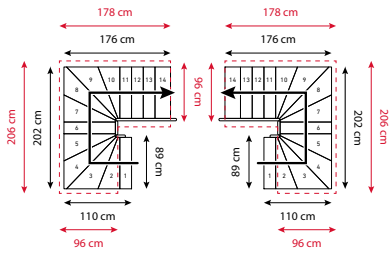

# HAMBURG HALF TURN DIMENSIONS

